

PET CONTAINMENT SYSTEM

Owners Manual

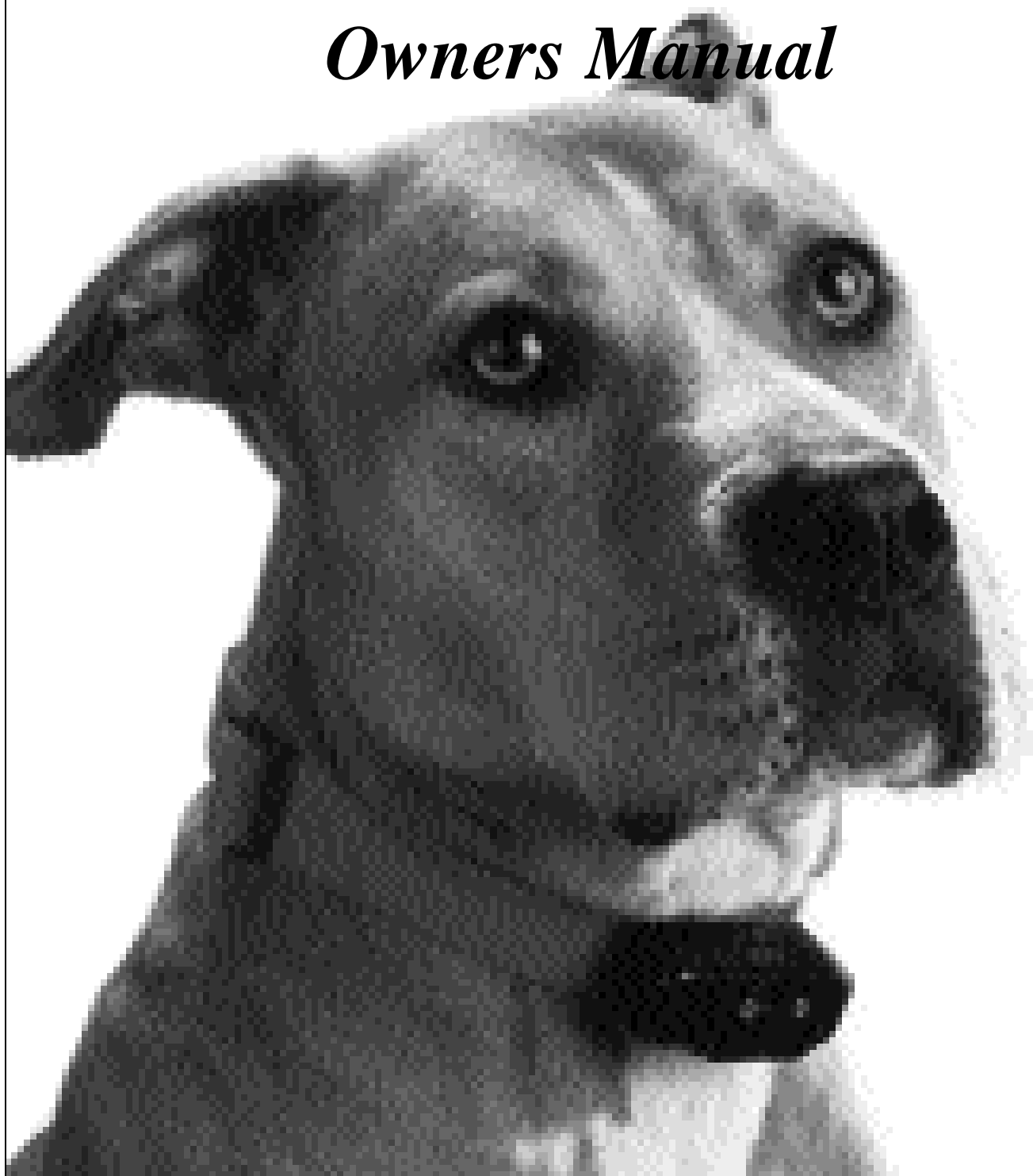

IMPORTANT



WE CAN HELP YOU!

Should you encounter any problems with your new product, please refer to this instruction manual. Be sure to file this manual in a safe place for future reference.

If you should need assistance, call our toll free "HELP" line at:



1-800-732-2677

online at: www.radiosys.com

Quick Start

Project Guide for Installing Your System

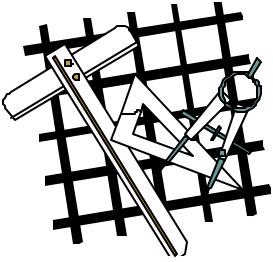
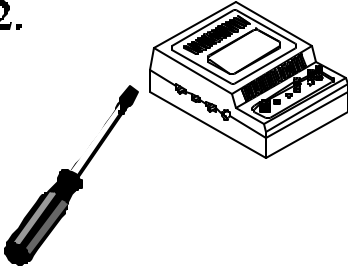
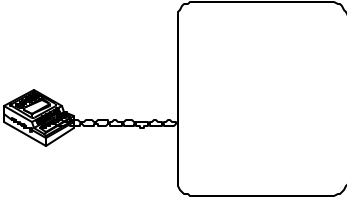
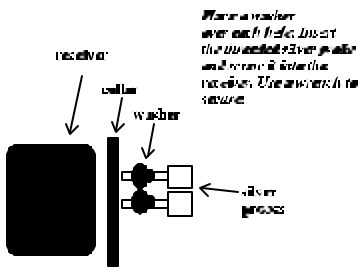
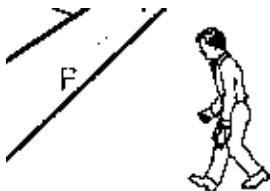
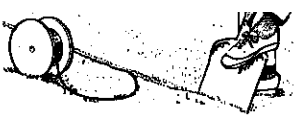
<p>1.</p>  <p>Lay out your "fence" on paper.</p>	<p>2.</p>  <p>Mount transmitter in a dry location (garage) using the template provided in this manual. Walk entire perimeter to test boundary.</p>	<p>3.</p>  <p>Lay wire above ground and connect to transmitter. Twist wire (16 twists per foot) from boundary to transmitter to cancel signal along this line.</p>
<p>4.</p>  <p>Assemble receiver. Attach collar and insert batteries.</p> <p><i>Place a washer over each hole. Insert the uncoiled silver probe and screw it into the receiver. Use a wrench to secure.</i></p>	<p>5.</p>  <p>Test system. Turn transmitter on and approach boundary. If it beeps, system is ready. Walk entire perimeter to test boundary.</p>	<p>6.</p>  <p>Bury wire 1" to 3" deep. Place flags every 10' inside wire where beep is detected.</p>

Training your pet

<p>1.</p>  <p>Walk to the boundary holding the receiver; with dog on a leash, shake flag and say NO. Repeat this around the entire boundary.</p>	<p>2.</p> <p>Place the receiver collar on pet. Attach a leash on a separate collar. Allow the pet to approach the boundary freely and receive a correction. Lead him back into the safe zone and praise him. Shake the flag and say NO. Walk the perimeter. Continued correction only if dog freely does so.</p>	<p>3.</p>  <p>Repetition necessary. Repeat training steps 1 and 2 for 14 days, since each day.</p>
<p>4.</p>  <p>Congratulations! You may now let your pet run.</p>	<p>5.</p>  <p>After 30 days, begin removing flags; every other one every other day.</p>	<p>6.</p> <p>Regular monthly maintenance</p> <ul style="list-style-type: none"> <input checked="" type="checkbox"/> Check batteries. <input checked="" type="checkbox"/> Check probes for tightness. <input checked="" type="checkbox"/> Clean probes with alcohol. <input checked="" type="checkbox"/> Check your pet's neck for any irritation and wash neck. <input checked="" type="checkbox"/> Walk the perimeter and remind your pet of the boundaries.

TABLE OF CONTENTS:

I. Introduction	5
II. Installation	6
III. Training your pet	10
IV. Maintenance	11
V. Troubleshooting	12
VI. Return procedure	14
VII. Accessories	14

What your Pet Containment System IS and IS NOT

IS a deterrent to train pets to remain within the boundary established.

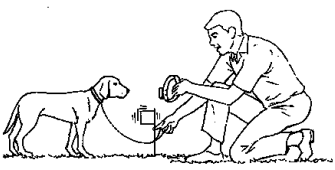
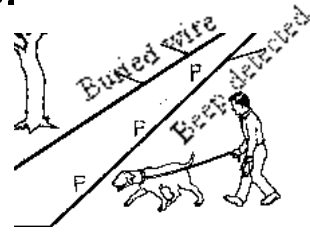
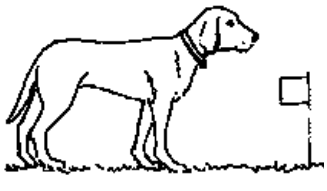
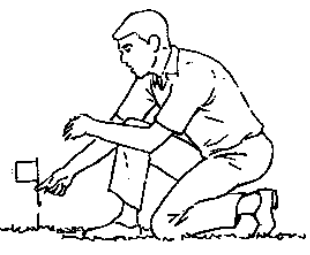
IS a great training aid.

IS for residential use only.

IS for healthy dogs. If you have doubts, contact your veterinarian.

IS NOT a solid barrier. It will not work without proper training.

IS NOT for use with vicious animals or guard dogs. If you believe your dog may pose a threat to others, DO NOT USE THIS SYSTEM.

IS NOT to be operated by children.

Radio Systems Corporation shall NOT be liable for any property damage, economic loss or any consequential damages sustained as a result of an animal crossing the boundary.

I. Introduction

1 How the system works

The Pet Containment System consists of three primary components: **TRANSMITTER**, **RECEIVER**, and **BOUNDARY WIRE** (antenna). The transmitter is a very low frequency radio transmitter that plugs into a standard outlet. The signal it transmits is carried by the boundary wire which serves as an antenna. The range of the signal (i.e. the distance from the boundary wire to activate the receiver) can be adjusted from a few feet up to thirty feet by the range adjustment knob located on the transmitter.

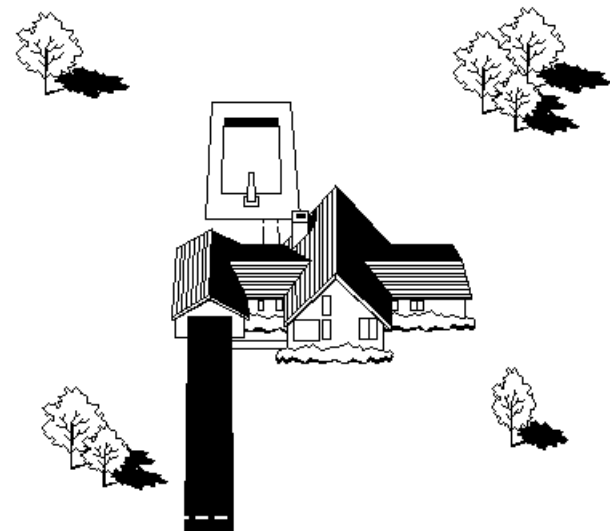

2 Components included

- Transmitter (Standard or Deluxe)
- Receiver (Standard or UltraLight)
- Collar
- An extra set of probes and washers
- Battery
- Video
- Owners Manual

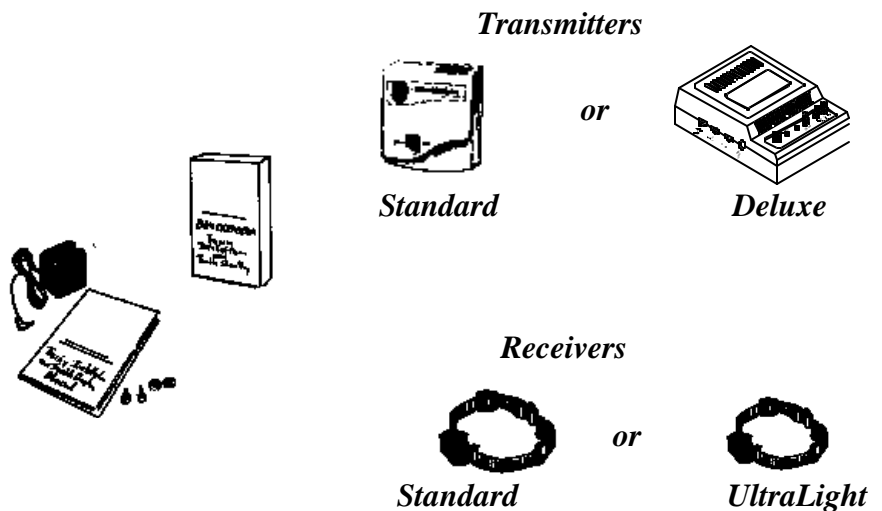

Required but may be sold separately

- 50 boundary training flags
 - 500 feet of boundary wire (18 gauge multi-stranded)
 - Wire nuts or wire fastener
- Use only Pet Containment System wire.*

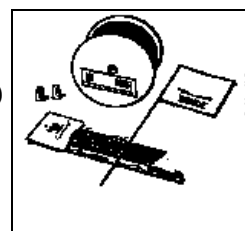

*Wire & Flag
Accessory Kit*

Other items you may need

- Straight edged spade or a lawn edger.
- Wire stripping pliers.
- Electrical tape.
- Waterproofing compound (e.g. silicone caulk).
- Patching compound if crossing concrete.
- PVC pipe if crossing a gravel or dirt driveway, pond or lake.
- Grounding rod and clamp.

Frequently asked questions

Q: How much area can the transmitter in my kit enclose?

A: The Standard transmitter will enclose up to 25 acres, the Deluxe transmitter up to 100 acres.

Q: Will the correction hurt my pet?

A: The correction will get your dog's attention, but will not harm him. The static shock is similar to that of static electricity, and is designed to startle, not punish.

Q: How deep do you have to bury the wire?

A: 1 to 3 inches. The only reason for burying is so you don't accidentally trip over it or cut it.

Q: How many dogs can be put on the system?

A: An infinite number but each must be wearing a receiver collar.

Q: What size or type pet can be used on the system?

A: The pet must be trainable and able to comfortably wear the receiver.

Q: Can the receiver be used on my pet's present collar?

A: Yes.

Q: How often do you have to replace the battery?

A: Every 3 to 6 months. Battery life depends on how often your dog tests the boundary & the type of battery used.

Q: How long does it take to install?

A: Allow about 2 to 3 hours for a 500 ft. fence. It depends on layout, soil conditions, tools, etc. A typical installation can be completed in one afternoon.

II. Installation

Lay out the area you plan to fence on a sheet of graph paper. The transmitter will transmit a signal up to 30 ft. on either side of your boundary wire. Be sure to leave enough area so that your dog can move about freely within the boundaries.

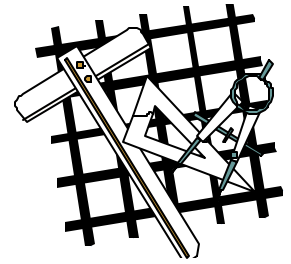

Basic planning rules

- The wire must make a continuous loop back to the transmitter.
- Twisting the wires cancels the signal. However, twisting three or more wires does not cancel the signal. Wires must be traveling in opposite directions to cancel the signal. Make at least 10 twists per foot.
- Always round corners (6 foot radius turns) Square corners distort the signal.
- When installing a double loop, wire must be separated three to five feet to avoid cancelling the signal.

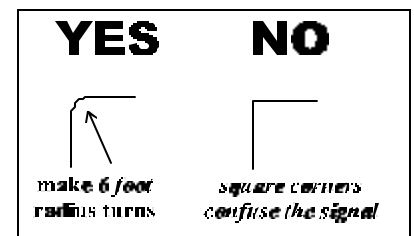
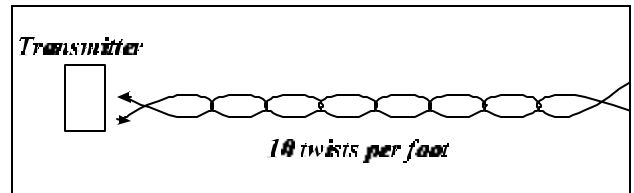

Sample layouts

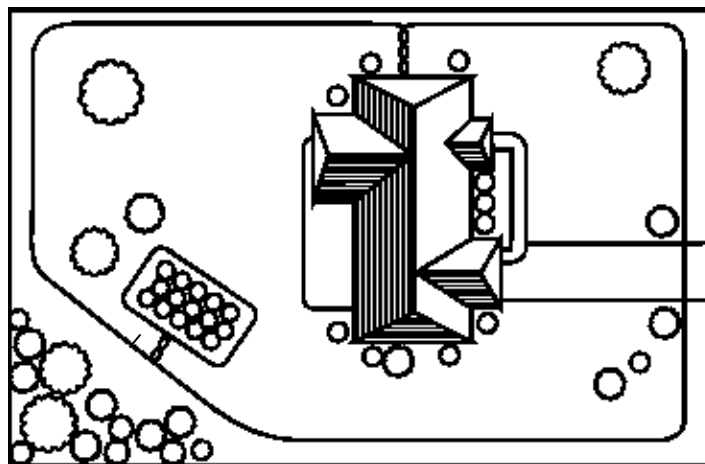

Entire yard and garden protected

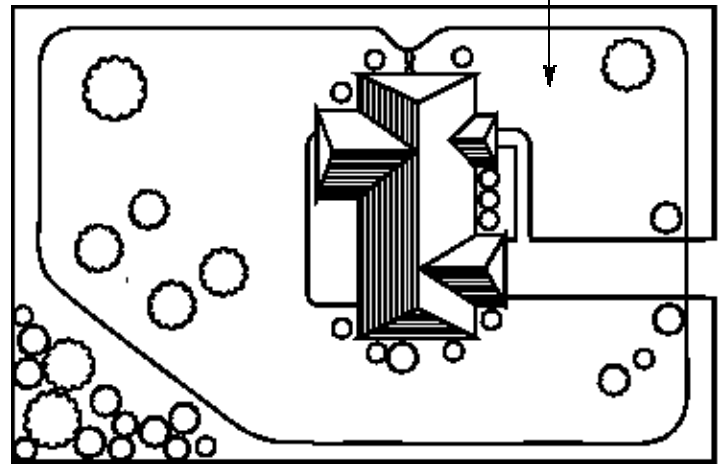

Front boundary with existing fence

Twisting wire cancels the signal

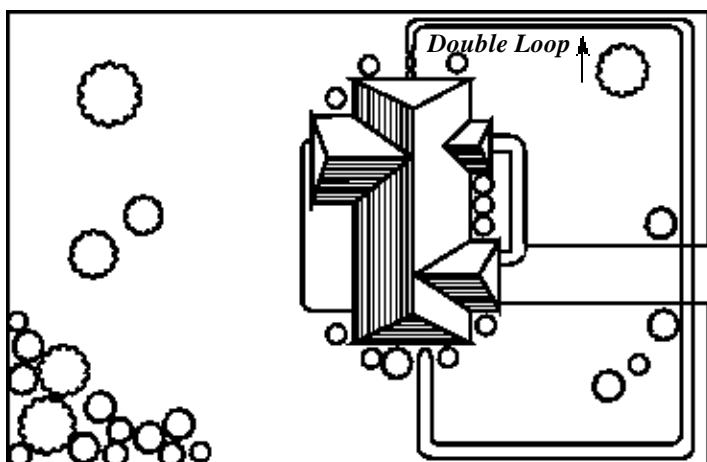

Front or back yard

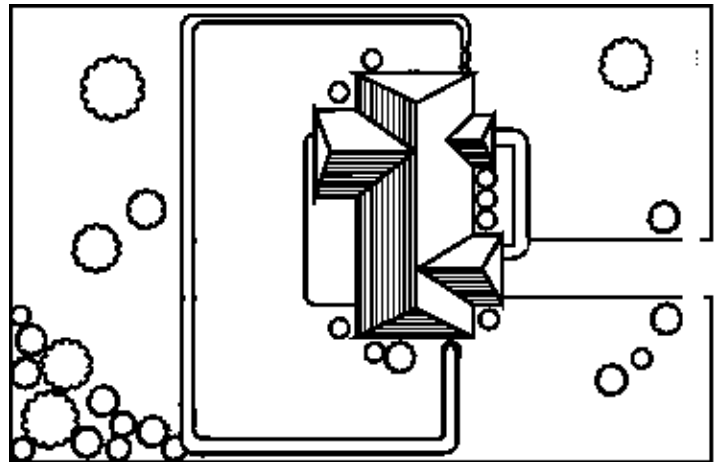

Back yard only

DO'S and DON'TS of installation

DO read all installation instructions before starting.

DON'T run wire parallel to electrical wires, telephone wires, television cables or antenna, or near satellite dishes.

DON'T run parallel to power, telephone or other cables. If you must cross, do so at 90° angles.

DON'T mount the transmitter near any large metal objects such as breaker boxes, water heaters, metal garage door tracks, or washer and dryer.

1 Locate the transmitter

INDOORS ONLY, near an electrical outlet, and close to your anticipated ground connection (see page 9).

Secure the transmitter to a mounting surface using the appropriate mounting hardware and use the mounting templates located in the back of this manual.

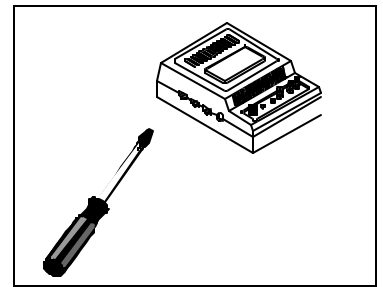

2 Lay wire.

Lay the wire along your proposed boundary. Connect it to the transmitter and turn the system on. Then, test the collar on the boundary wire to ensure it is working properly. Walk the entire perimeter to test the boundary. Assemble your receiver Collar first, described on page 9.

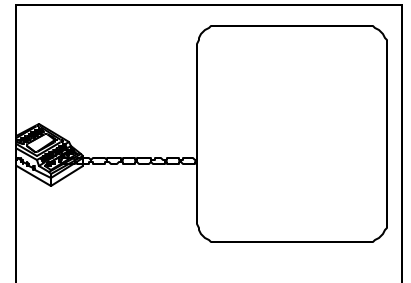

3 Splicing wire.

If you use more than the 500 ft. of wire, you will need to splice the wire together with the wire nuts.

Note the location of all splices and file it with your manual to keep for future reference. Most wire breaks occur near or at the splices.

Begin by stripping the ends of the wires to be spliced. Insert the stripped ends into the wire nut and twist, then pull making sure of a solid connection. Apply water-proofing compound (like silicone) in and around wire nut. After the compound dries, you may also wrap wires and wire nut with electrical tape to prevent them from pulling loose and to protect from moisture. If your splice or connection pulls loose, your entire system will fail. Make sure of a secure connection.

4 Burying the wire.

Cut a trench one to three inches deep along your previously planned boundary. Burying the wire is recommended to prevent damage to the wire or transmitter and to avoid possible injuries to persons tripping over the exposed wire. Be sure to maintain some slack. The wire will expand and contract with temperature variations.

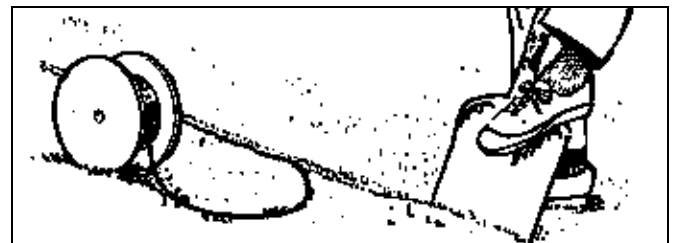

5 Crossing hard surfaces

Lay the wire in a convenient expansion joint or use a circular saw with a masonry blade to create a groove. Place the wire in the groove and cover with an appropriate patching compound. Your local hardware store can help you choose the right compound for your type of driveway.

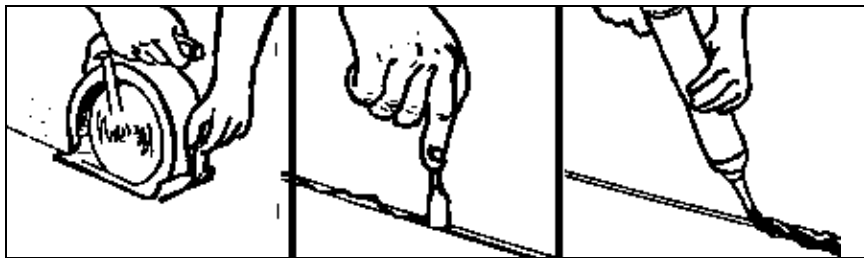

6 Hooking up your transmitter.

Standard transmitter

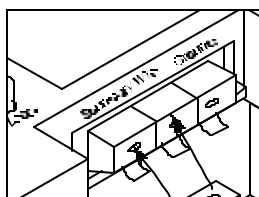

1. Connect boundary wire to red wire terminals.
2. Connect earth ground using a length of wire to the black terminal.

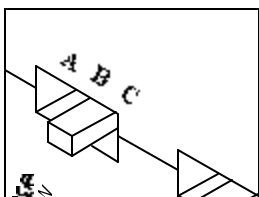

3. Try each of the three boundary settings to determine the best signal range.

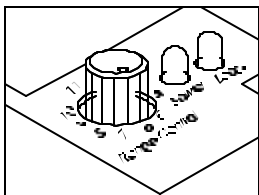

4. Turn range control knob to full clockwise.
5. Plug in the AC adaptor into an outlet and into the power jack on the transmitter. The power Indicator and loop condition indicator lights should glow.

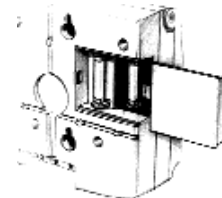
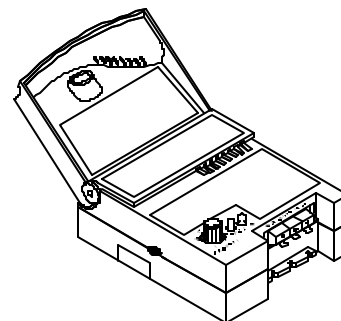

*back view
fuse holder and spare fuse*

Deluxe transmitter:

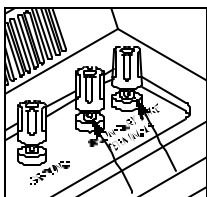

1. Connect boundary wire to boundary wire terminals.
2. Turn Range knob all the way to the right.

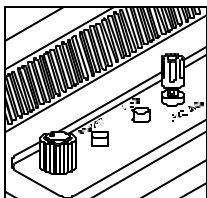

3. Plug the AC adaptor into an outlet and plug into the power jack on the transmitter.
4. Turn the power switch ON. The Power Indicator and Loop Connection Indicator Lights should glow.

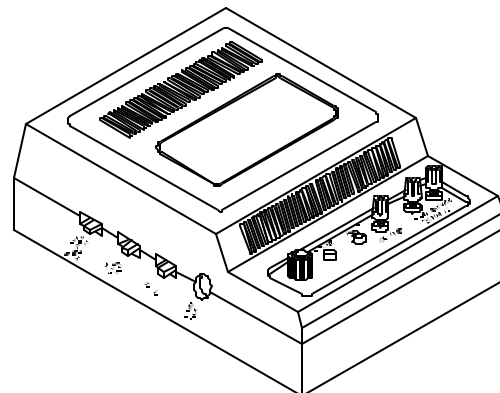

7 Set boundary

Adjust the range control knob to set warning beep at a range best for your yard. We recommend a minimum of five feet. Have as wide a signal area as possible while still giving your pet a sufficient “safe zone”.

8 Grounding your transmitter

Proper grounding is necessary to reduce the chance of lightning damage to your transmitter. Connect a wire between the transmitter and a ground rod buried at least 3 ft. into the ground. You may use an existing ground rod. Ground rods with clamps and 14 to 18 gauge wire may be obtained at most electrical supply stores. Locate the transmitter as close as possible to the ground rod.

9 Receiver collar assembly

STEP 1: Measure your pet's neck, mark the appropriate length, and cut off the excess collar, allowing room for growth. Seal the edge of the cut by taking a match or lighter along the frayed edge.

STEP 2: Thread slide buckle onto the collar first.

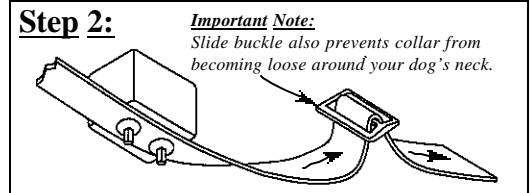

STEP 3: Thread end of the collar up through the buckle.

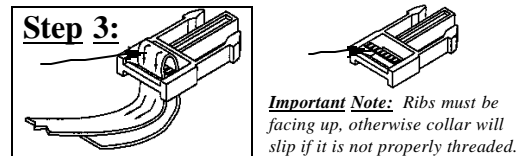

STEP 4: Thread excess collar through the slide buckle to hold it in place. This will allow you to adjust your pet's collar as he grows.

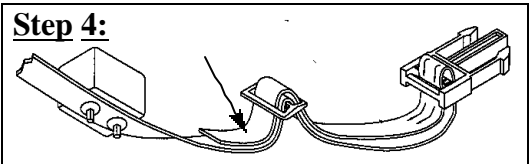

Using a collar you supply

Punch holes in your collar using the collar supplied as a template.

Installing batteries

UltraLight receiver.

Install **TWO** 3 Volt lithium batteries (model 2032). Be sure to install with the proper polarity (+,-).

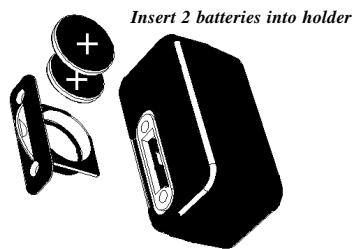

Standard receiver.

Install one 6 Volt alkaline battery. Be sure to install the battery with the proper polarity (+, -).

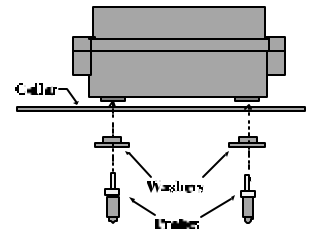
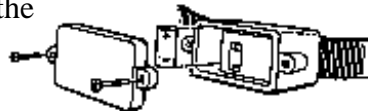

Placing the collar on your pet

Make sure the receiver is positioned directly on your pet's throat. Ensure the probes touch the skin but are not so tight as to be uncomfortable to your pet. When the collar is properly positioned you should be able to get one finger between the probes and your pet's skin.

Do not leave collar on too tight! Doing so can cause Pressure Necrosis, a condition where the skin deteriorates. Check and clean your pet's neck regularly. If a rash or sore forms, take the collar off for a few days. When replacing it, make sure that it is not too tight and to keep your pet's neck clean.

Congratulations! You are now ready to begin training!

IV. Training your pet

Training tips

- Even though your dog may appear trained after one or two days, it is important to continue the training for the entire fourteen day period.
- During the training period, your pet should be contained by other means and only be allowed in your yard on a leash. It should not be allowed to freely cross the boundary at any time.
- Training can be very tiring for your pet so limit training periods to 10 or 15 minutes.
- Let other family members share in the training so that your pet doesn't relate the training to only one member of the family.
- If your pet becomes hesitant of the training process, remove the receiver collar and resume training the next day and alternate every other day after that.

Boundary training flags

Place boundary flags ten feet apart and at the point where the warning beep starts. The flags serve as a temporary visual boundary for you and your pet. The flags will later be removed when your pet has become familiar with the "safe zone".

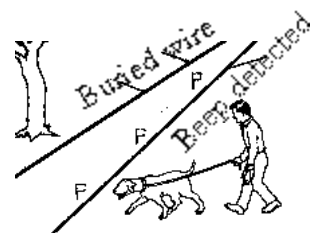

Boundary Training

- 1** Hold the receiver in one hand and, using a leash, walk your pet to the boundary. Shake a boundary flag and give your pet a strong "NO" command, allowing it to hear the beeping from the receiver.
- 2** Lead him back into the yard and praise and play with him.
- 3** Repeat steps 1 and 2 around the entire boundary.
- 4** After a short rest/play period, place the receiver collar along with the collar with leash on your pet.
- 5** Let your pet experience a correction by walking into the signal field on his own. Then, immediately lead him back into the "safe zone" and praise him. Do not encourage the pet to cross the boundaries, as this will confuse him. If your pet will not venture into the signal field on its own, have someone else cross the boundary and allow the pet to follow.
- 6** Repeat step 5 again around the perimeter boundaries. Your pet should receive a correction only when it willingly attempts to cross the boundaries. Additional corrections are not necessary unless your pet willingly attempts to approach the boundary.
- 7** Remove the receiver collar. **DO NOT** leave your pet alone with the receiver collar until fully trained.

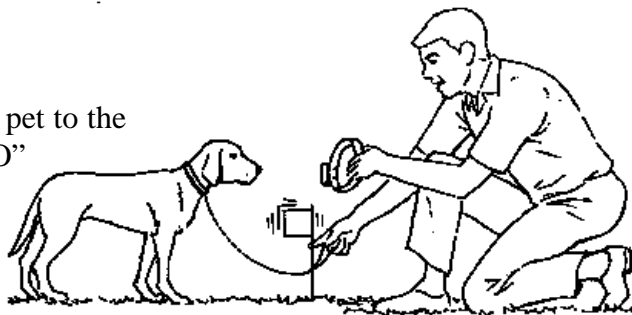

DAYS 2 THROUGH 14

Repeat steps 4 through 7 at least once per day.

Days 15-30

When your pet shows learning progress, remove the training leash and allow it full use of the “safe zone”
After 30 days from the start of training, remove every other boundary flag. Repeat every other day.

Imaginary gate training

- 1** Remove the receiver collar and replace with a regular collar and leash.
- 2** Walk your pet out to a specific place in your yard, preferably the end of your driveway. Always lead it out at this spot and with the lead. If he refuses to cross, help him through by pulling on the collar.
- 3** Your pet will gradually learn that it must wear a leash to venture outside the boundaries. Alternate several members of your family during this process so that your pet identifies leaving with the leash and not with the person.

IV. Regular maintenance

Perform each of the following:

- **Check batteries (monthly).**
- **Check probes for tightness (weekly).**
- **Check your pet’s neck for any irritation and wash neck (daily).**
- **Walk the perimeter and remind your pet of the boundaries (monthly).**

V. Troubleshooting

System test using short loop

1 Disconnect the boundary wire and ground wire. Then, connect a 10 foot piece of wire to the terminals and spread it out in a circle. Set the boundary size switch to B (middle) position with Standard transmitter or low with deluxe transmitter.

2 Turn the range knob full clockwise

Power light on? If not, check fuses.
If the fuse is good, see “Return Procedure”.

Loop light on? If not, see “Return Procedure”.

3 Disconnect one end of the wire

Alarm beep? If not, see “Return procedure”.

If yes, transmitter is good.

4 Reconnect wire, turn the range knob all the way to the right, approach boundary with receiver

Receiver beeping? If not, check batteries for proper installation and that they are still good.
If batteries are good, and installed correctly, see “Return Procedure”.

If yes, receiver is good.

Inspect wire

If the transmitter and receiver check out good on above tests but receiver does not beep on boundary wire, the wire is broken or your system is not installed properly. Walk your perimeter Some breaks may be too small to cause loop light to go out or break alarm to activate. Check your splices. Most breaks in the wire occur in the splices. See “How to locate a break in the wire” for more help.

Testing Correction

Using an option test light (Radio Shack™ model # 272-1100) or call our Service Center to purchase one) and attach to probes. Carry the receiver to the boundary wire. When beep changes from high tone to low tone, the test light should light. If not, see “Return Procedure”.

Pet does not appear to receive correction?

✔ Trim hair in the area of the probes to insure contact.

✔ Use long probes.

Pet ignores correction and runs through system

✔ Reinforce training

✔ Increase signal area.

✔ Check batteries, weak batteries can weaken correction.

✔ Call 1-800-732-2677 and inquire about Stubborn Dog Receiver.

How to locate a break in the wire

1. Connect both ends of your twisted boundary wire to the first terminal on your transmitter.
2. Measure and cut a new piece of boundary wire that is 1/2 the length of your boundary loop.
3. Connect the new wire to the second terminal on the transmitter.
4. Locate the half- way point along your boundary loop.
5. Cut your boundary loop at the half-way point.
6. Connect the free end of your new piece of wire to either side of your boundary loop at the half way point.
7. Turn the system on and check the range of this smaller loop with the receiver collar.
8. If there is no improvement in the performance of your system, you may assume that there is a break in this portion of your boundary. Because there is a small chance you have more than one break in your loop, you should also try the same procedure for the other side of your loop.
9. Once you determine a section of your boundary loop has a break in it, find the middle of that section and cut the wire. Be sure to resplice the first cut that you made and make it waterproof by caulking with silicone.
10. Connect the new wire to your boundary loop at the point at which you made the cut in STEP 9.
11. Turn the system on and check the range of this smaller loop with the receiver collar.
12. Repeat STEPS 8 - 11 until you find the damaged section of wire .
13. Replace damaged wire with new wire. Remember that all wire in your boundary loop must be the exact same size and type.

VI. Return Procedure

Send your product with a brief description back to the address below complete with a legible return address. No prior authorization is needed. We recommend you ship your return via a carrier that offers tracking capabilities. *You must pay the shipping or freight charges to us. We will then pay the freight charges back to you.*

Your product will be repaired or replaced immediately and shipped back to you. There is a nominal labor charge for out of warranty products but all parts are free during the warranty period. If you have had your system for more than one year, call the customer service at 1-800-732-2677 to determine the labor charge.

RSC, Service Warehouse, 10427 Electric Ave., Knoxville, TN 37932

Please remove the collar, probes and batteries from the receiver before shipping it.

VII. Accessories

- RF-204 Stubborn Dog receiver**
With trade in of Standard or Ultralight receiver
- Correction reduction resistors for lowering shock level**
Each resistor reduces shock by 20%
- Replacement probes**
- Surge Protection Kit for storm prone areas**

Call 1-800-732-2677 to order.

Notes:

Transmitter templates

DELUXE TRANSMITTER

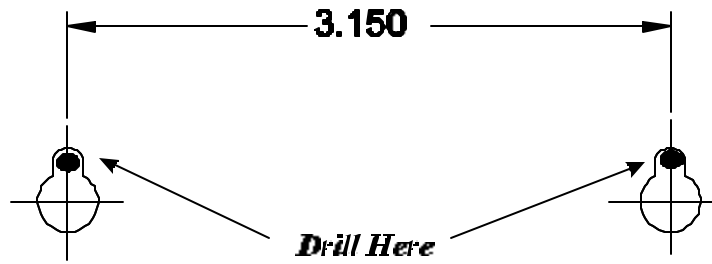

1 to 1 scale

